

INCH



FLANGED FULL BORE BALL VALVES

ANSI CLASS 150 & 300

73P/74P SERIES



 **HABONIM**
Industrial Valves & Actuators

DEDICATED TO INNOVATION

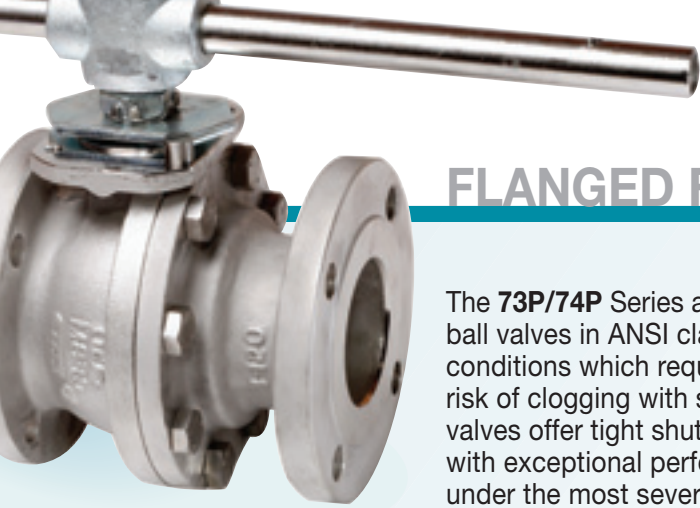

FLANGED FULL BORE BALL VALVES

The **73P/74P** Series are **HABONIM**'s line of flanged full bore ball valves in ANSI class 150 and ANSI class 300. Ideal for conditions which require maximum pressure drop, reducing risk of clogging with solids or slurries, HABONIM's full bore valves offer tight shutoff, long service life and high durability with exceptional performance in many service applications under the most severe working conditions.

Technical Summary

Size Range:	½" - 6"
Flange Connection:	73P Series - ANSI class 150 74P Series - ANSI class 300
Application:	Chemical, Petrochemical, Oil and Gas production, Refining, Energy, Pulp & Paper and others
Service:	Steam, Chemicals, LP-Gas, Thermal Fluid, Chlorine, Ammonia, Sour Gas
Materials:	Carbon Steel, Stainless Steel, Hastelloy-C22, Hastelloy-C276, 254SMO, Alloy-20, Monel, Duplex, Inconel
Certifications:	Firesafe to API 607 5 th Edt., ISO 10497, API 6FA Lloyds Type Approved to ISO 17292 & API 6D, PED 97/23/EC, ATEX Directive 94/9/EC
Operation:	Hand or Gear operated, Pneumatic, or Electric Actuated

Antistatic

The valve stem has a built in antistatic device which ensures continuous contact of stem-to-ball and stem-to-body.

Valve's Refinement

Carbon Steel valves are phosphated and oil dipped. Stainless Steel valves are natural finish.

Interchangeability

Valve ball, stem, seats and seals are interchangeable with the Habonim **47P/46 Series** three piece ball valves.

Fire Safe Valves

Fire Safe valves are designed and tested to the requirements of API 607 5th Edition and to ISO 10497 specifications. Valves for fire safe application are identified by the prefix "**AF**". Fire Safe certificates for valves should be requested, if required.

Construction

Valve sizes ½" to 1" are one piece design. Valve sizes 1½" to 6" are split body design. All valves have a top mounting flange conforming to ISO 5211 for direct mounting of actuators, limit switches, fugitive emission bonnets or extended handles.

Seats

Flexible seat design provides tight shutoff at high and low pressures, reduced wear and valve torque. A wide range of seat materials are available. Standard seat materials are Virgin PTFE, glass filled PTFE or carbon-filled PTFE. For other seat materials, please refer to Bulletin T-624, or consult with Habonim.

Stem

The valve stem assemblies have blowout proof stems with live loaded disc springs to compensate for pressure and temperature surges and wear.

Ball

A highly polished solid ball with a pressure relief hole in the stem slot to equalise the pressure in the body cavity ensures tight shutoff and long service life.

Body and Trim Materials

The standard valve body materials are 316 Stainless Steel and Carbon Steel grades WCB and LCB. Standard trim material for ball and stem is 316 Stainless Steel. Trim materials such as Monel, Hastelloy-C22, Alloy-20, Duplex and others are available for specific applications.

Secondary sealing

All fire safe valves are fitted with flexible graphite body seals and graphite stem seals.

The valves contain soft seat rings. In the event of fire, a secondary metallic machined ring comes in contact with the ball and prevents leakage through the valve port. The stem incorporates a machined ring shaped surface which will prevent leakage, once the thrust seal has been burnt off.

Special Service

Valves prepared for special services such as Dry Chlorine, Oxygen, Hydrogen Peroxide, Ammonia, Vacuum, Steam, Thermal fluids and low temperature service are in accordance with the relevant standards.

Other design applications available include Control valves with V-Ported seats and Double - Block & Bleed valves. Diverter valves and Steam Jacketed valves are optional up to 2" only. Sour gas service valves are to NACE MR-01-75. Ask for the relevant bulletins for all these applications.

Other available accessories:

Stem extensions for valves.

Fugitive emission kits for hazardous fluids.

Locking devices for securing valve position.

Manual gear operators for operating large valves.

Declutchable gear operators for actuated valves.

Spring return handle (Dead man lever) for dependable automatic closing or opening of valves.

Limit switches for on-off indication.

Pressure / Temperature Rating (Seat Material)

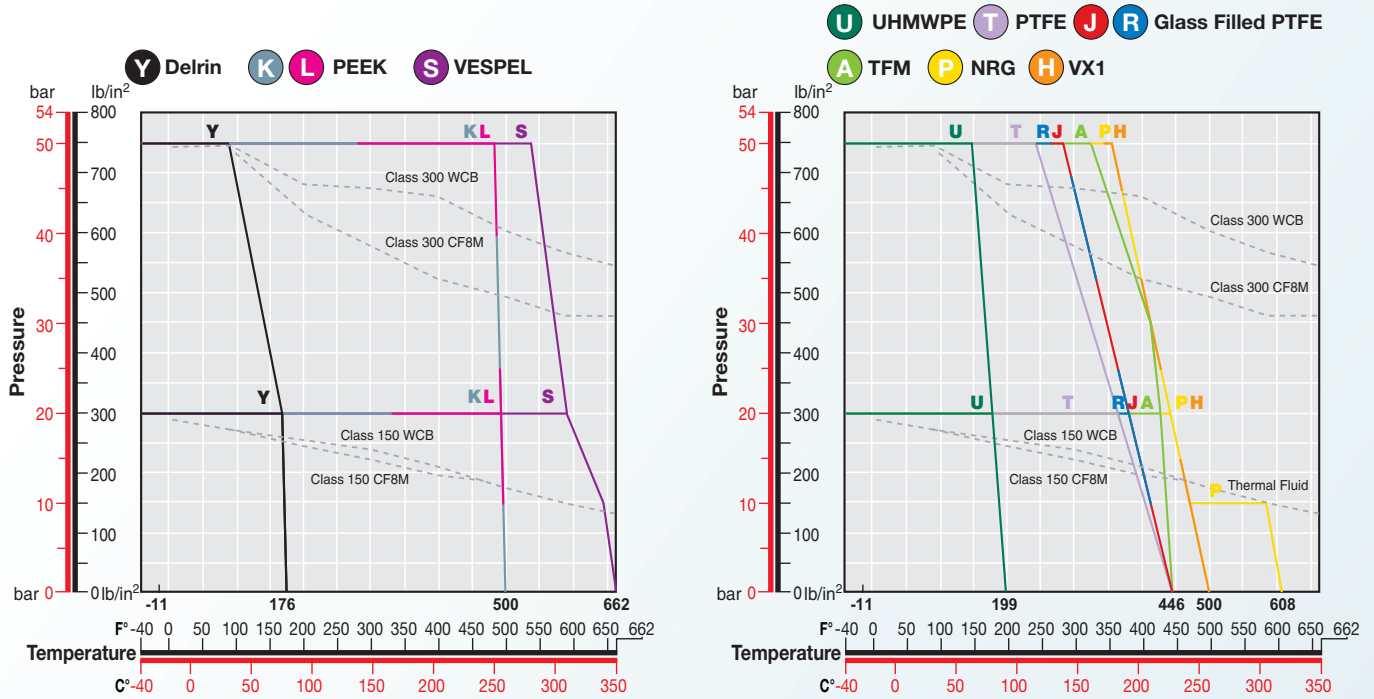

The pressure/ temperature rating is determined by the valve flanges and by the seat rating. Temperature ranges from -40°C to 350°C. Valves fitted with PEEK, DELRIN & VESPEL seats are assembled with PEEK, NYLATRON, VESPEL thrust seal accordingly and SS 17-4PH stem.

Valve Options

The HABONIM distinctive ability to engineer solutions for special applications has resulted in many designs. Some of the various valve designs and accessories that HABONIM have available with the 73P/74P series are shown below. For more information and other options, please consult with Habonim.

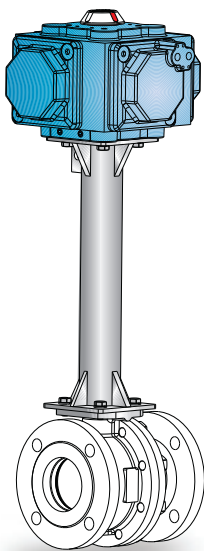

Actuator Extension

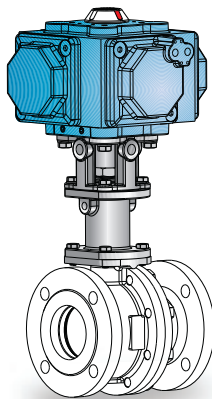

Fugitive Emission with actuator

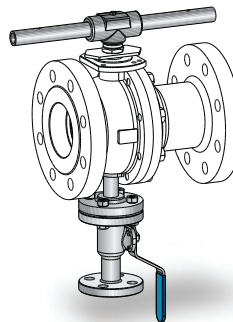

Double Block & Bleed

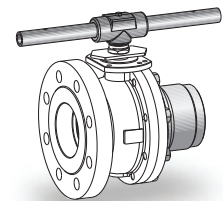

Buttweld end

Valve Size	Cv Values		Limiting Stem Input Torque*			
	Flow Coefficients		316 S/S Stem material		17-4PH Stem material	
Inch	Cv	Kv	Nm	in-lb	Nm	in-lb
1/2"	30	26	13.2	117	91	805
3/4"	50	43	24.4	216	165	1,460
1"	100	86	24.4	216	165	1,460
1 1/2"	250	216	48.6	430	268	2,370
2"	480	414	-	-	268	2,370
3"	1,300	1,120	385	3,400	1,930	17,000
4"	2,400	2,070	-	-	1,930	17,000
6"	5,400	4,660	1,570	13,900	7,500	66,375

Cv - Flow in US GPM at 1 psi pressure drop.

Kv - Flow in m³/hr at 1 bar pressure drop.

Valve flow rates are determined in full open position with water at 15°C (60°F).

* Limiting Stem torque figures are based on random laboratory tests.

These are not to be confused with valve operating torque.

FLANGED FULL BORE BALL VALVES

Valve Specification 1/2"-1"

Item	Description	Material Specifications	Qty.
1	Body	Stainless St. ASTM A351 CF8M, Carbon St. ASTM A216 WCB	1
2	Insert	Stainless St. ASTM A351 CF8M, Carbon St. ASTM A216 WCB	1
3	Ball	Stainless St. ASTM A351 CF8M	1
4	Stem	Stainless St. ASTM A276 316 / 316L	1
*5	Seat ring	PTFE, RPTFE, NRG, PEEK, TFM, UHMWPE	2
*6	Body seal	PTFE, UHMWPE, Graphite	1
*7	Stem thrust seal	RPTFE, NRG, PEEK, TFM, UHMWPE	1
8	Stop pin	Stainless St. ASTM A582 303	1
*9	Stem packing	NRG, RPTFE, TFM, UHMWPE Graphite	1
10	Follower	Stainless St. ASTM B783 316L	1-2**
11	Disk springs	Stainless St. 17-7PH	2
12	Stem nut	Stainless St. ASTM A194 316	1
13	Locking clip	Stainless St. ASTM A164 304	1
14	Handle	Stainless St. ASTM A240 430 Carbon St. ZINC Plated	1
15	Serrated washer	Stainless St. 410	1
16	Handle nut	Stainless St. ASTM A194 316	1
17	Sleeve	Vinyl Plastisol	1
18	Anti static spring	Stainless St. AISI 302	1
19	Anti static ball	Stainless St. AISI 304	1
20	LD housing	Stainless St. ASTM A351 CF8	1
21	LD stem	Stainless St. ASTM A351 CF8	1
22	LD spring	Stainless St. ; Music wire	1
23	LD circlip	Spring St.	1

* Standard items for repair kits ** 2 followers are used on 1/2"
The materials above are for standard applications. Other materials are available.

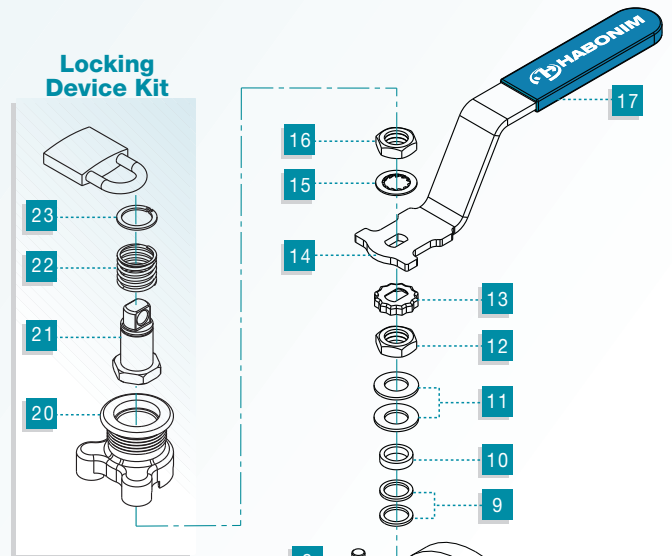

Stem dimensions

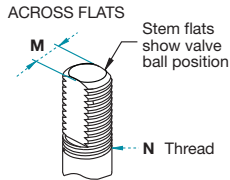

Preparation for actuation

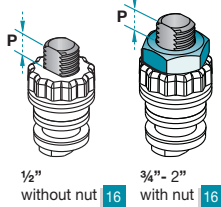

* See stem dimensions for 1 1/2"-2" valves on page 5

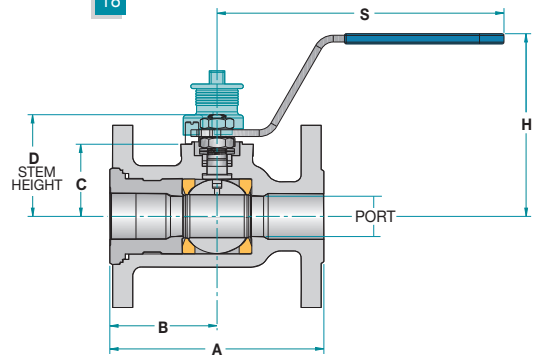
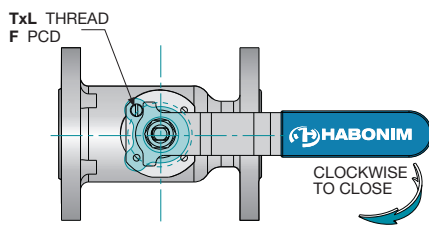

Valve Size	Port Dia.	A		B	C	D	H	S	M	N	P	F	TxL	App. Weight kg./lb		
		150	300											150	300	
1/2"	mm	14.3	108.0	140.0	48.0	31.4	40.5	94.0	151.0	5.54	3/8"-24	11.1	36.0 (F03)	M5x10	1.8	2.3
	in	0.563	4.252	5.512	1.890	1.236	1.594	3.701	5.945	0.218	UNF-2A	0.437	1.417	M5x10	4.0	5.1
3/4"	mm	20.6	117.0	152.0	58.0	38.2	55.6	103.5	170.0	7.54	3/8"-24	15.4	42.0 (F04)	M5x10	2.2	3.3
	in	0.811	4.606	5.984	2.283	1.504	2.189	4.075	6.693	0.297	UNF-2A	0.606	1.653	M5x10	4.8	7.3
1"	mm	25.4	127.0	165.0	63.5	42.70	60.3	108	170.0	7.54	7/16"-20	15.4	42.0 (F04)	M5x10	3.2	4.6
	in	1.000	5.000	6.500	2.500	1.680	2.370	4.250	6.690	0.296	UNF-2A	0.606	1.653	M5x10	7.0	10.1

Valve Specification 1½"-6"

Item	Description	Material Specifications	Qty.
1	Body	Stainless St. ASTM A351 CF8M, Carbon St. ASTM A216 WCB	1
2	End Cap	Stainless St. ASTM A351 CF8M, Carbon St. ASTM A216 WCB	2
3	Ball	Stainless St. ASTM A351 CF8M	1
4	Stem	Stainless St. ASTM 276 316 / 316L	1
*5	Seat ring	PTFE, RPTFE, NRG, PEEK, TFM, UHMWPE	2
*6	Body seal	PTFE, Graphite	1
*7	Stem thrust seal	RPTFE, NRG, PEEK, TFM, UHMWPE	1
8	Stop pin	Carbon St. ASTM A29 GR 1020	1
*9	Stem packing	Graphite	3
10	Follower	Stainless St. ASTM B783 316L	1
11	Stop plate	Carbon St. ZINC Plated	1
12	Tab lock washer	Stainless St. ASTM A240 304	1
13	Stem nut	Carbon St. ZINC Plated	1
14	Wrench head	Malleable Iron	1
15	Wrench handle	Carbon St. ZINC Plated	1
16	Wrench bolt	Stainless St. AISI 304	1
17	Body bolt	Stainless St. ISO 4017 A2-70 Carbon St. ISO 4017 Gr. 8.8 ZINC Plated	4-8-12
18	Anti static spring	Stainless St. AISI 302	2
19	Anti static plunger	Stainless St. AISI 304	2

* Standard items for repair kits

Sizes 1½"- 2"

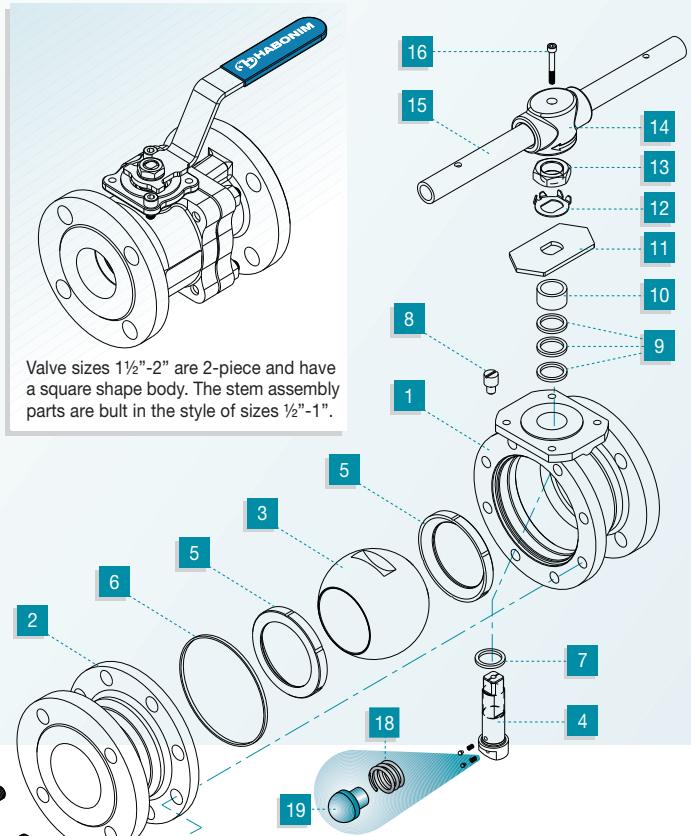

Stem Dimensions

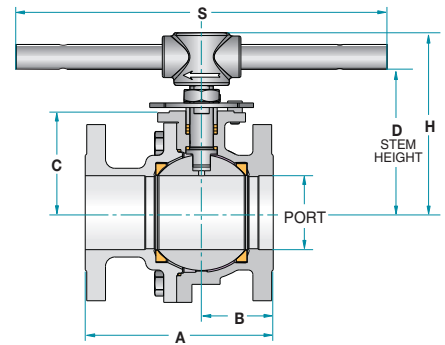
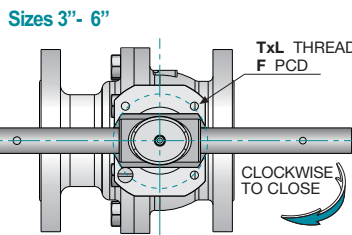
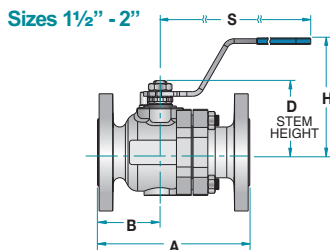
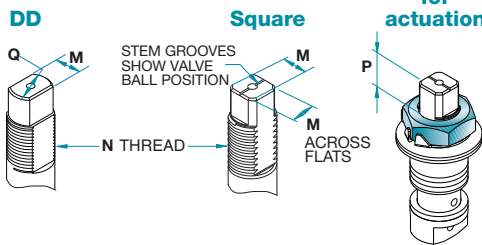

Valve Size	Port Dia.	A		B		C	D	H	S	M	M-DD	N	P	F	TxL	App. Weight kg./lb	
		150	300	150	300											150	300
40 mm	38.1	165	190	68.0	80.4	48.3	77.8	124.0	220.5	*8.7	-	*9/16"-18	*19.6	50 (F05)	M6x12	6.6	9.8
1½" in	1.50	6.5	7.5	2.68	3.17	1.90	3.06	4.88	6.68	*0.343	-	UNF-2A	*0.77	1.968	M6x12	14.5	21.5
50 mm	50	178	216	65.0	65.0	70.0	88.0	134.2	220.5	*8.7	-	*9/16"-18	*19.6	70 (F07)	M8x12	13.0	15.0
2" in	2.00	7.0	8.50	2.6	2.56	2.75	3.46	5.28	6.68	*0.343	-	UNF-2A	*0.77	2.755	M8x12	28.6	33.0
80 mm	80	203	283	79.0	85.00	108.0	154.6	194.80	400.0	18.9	15.9	1"-14	16.7	102 (F10)	M10x20	26.0	29.0
3" in	3.25	8.0	11.14	3.1	3.35	4.25	6.08	7.67	15.75	0.244	0.6	UNF-2A	0.66	4.015	M10x20	57.0	64.0
100 mm	100	229	305	82.0	94.0	124.0	170.6	211.0	610	18.9	15.9	1"-14	16.7	102 (F10)	M10x20	34.0	39.0
4" in	3.94	9.0	12.01	3.2	3.70	4.88	6.71	8.31	24.00	0.244	0.6	UNF-2A	0.66	4.015	M10x20	75.0	86.0
150 mm	150	394	403	168.0	168.0	179.0	248.5	308	916	28.4	23.8	1½"-12	26.2	125 (F12)	M12x20	71.0	78.0
6" in	5.91	15.51	15.87	6.6	6.61	7.05	9.78	12.12	36.00	1.11	0.94	UNF-1A	1.03	4.921	M12x20	156	172

* Dimensions relate to stem drawing on page 4

FLANGED FULL BORE BALL VALVES

73P/74P Series Automated Valve Dimensions

Actuation

Where automation is required, the 73P/74P series ball valves are available with Habonim's unique 4-Piston pneumatic Compact actuator. The Compact actuator is available in 8 sizes, spring return or double acting. All the valve mounting flanges are according to ISO 5211 and are suitable for accommodating any quarter turn actuator (pneumatic or electric) for valve automatization. Valves can be operated for on-off or throttling application. The actuators have a NAMUR air connection interface for attaching solenoids. Limit switches and positioners can be mounted on the actuator top face according to VDI / VDE 3845. For information, please refer to Bulletin B360.

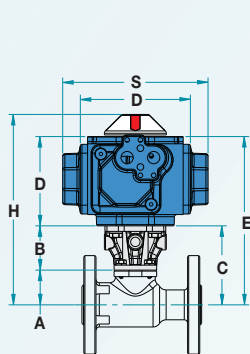

Sizes 1/2" - 1"

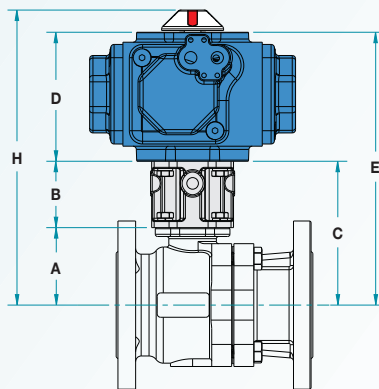

Sizes 1 1/2" - 2"

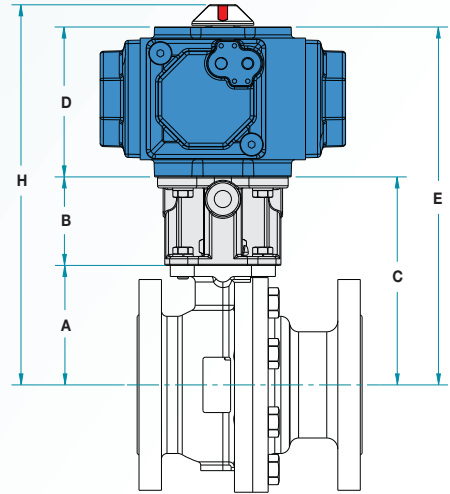

Sizes 3" - 6"

Valve Size	Actuator size	73P/74P Series					Compact Actuator		
		A	B	C	E	H	D	DA	SR
1/2" F03	C15	1.236	1.575	2.811	5.528	6.315	2.717	3.386	4.331
	C20		1.575	2.811	5.988	6.776	3.177	4.016	5.157
	C25		1.575	2.811	6.638	7.425	3.827	5.197	6.339
3/4" F04	C15	1.504	1.575	3.079	5.795	6.583	2.717	3.386	4.331
	C20		1.575	3.079	6.256	7.043	3.177	4.016	5.157
	C25		1.575	3.079	6.906	7.693	3.827	5.197	6.339
1" F04	C30	1.677	1.575	3.079	6.906	7.693	3.827	5.197	6.339
	C15		1.969	3.646	6.362	7.150	2.717	3.386	4.331
	C20		1.969	3.646	6.823	7.610	3.177	4.016	5.157
1 1/2" F05	C25	1.902	1.969	3.646	7.472	8.260	3.827	5.197	6.339
	C30		1.969	3.646	8.236	9.024	4.591	5.945	7.323
	C35		1.969	3.646	8.236	9.024	4.591	5.945	7.323
2" F07	C20	2.756	2.362	4.264	7.441	8.228	3.177	4.016	5.157
	C25		2.362	4.264	8.091	8.878	3.827	5.197	6.339
	C30		2.362	4.264	8.854	9.642	4.591	5.945	7.323
3" F10	C35	4.252	2.362	4.264	9.598	10.386	5.335	7.165	8.740
	C30		3.150	7.402	11.992	12.780	4.591	5.945	7.323
	C35		3.150	7.402	12.736	13.524	5.335	7.165	8.740
4" F10	C45	4.882	3.150	7.402	13.858	14.646	6.457	8.701	10.591
	C60		3.150	7.402	15.965	17.146	8.563	11.220	14.173
	C35		3.150	8.031	13.366	14.154	5.335	7.165	8.740
6" F12	C45	7.047	3.150	8.031	14.488	15.276	6.457	8.701	10.591
	C60		3.150	8.031	16.594	17.776	8.563	11.220	14.173
	C75		3.150	8.031	18.661	19.843	10.630	13.465	17.205
6" F12	C35	7.047	3.937	10.984	16.319	17.106	5.335	7.165	8.740
	C45		3.937	10.984	17.441	18.228	6.457	8.701	10.591
	C60		3.937	10.984	19.547	20.728	8.563	11.220	14.173
6" F12	C75	7.047	3.937	10.984	21.614	22.795	10.630	13.465	17.205

Actuator Sizing

Valve sizing tables of the Compact actuators on Habonim valves are available on request.

The sizing tables are based on valve size, differential pressure, valve seat types, working temperature, flowing media and frequency of operation.

The valve torque figures are calculated from tests using water at room temperature at different pressure drops for each seat material and actuator air pressure.

Please consult with HABONIM for more details.

Actuator Sizing Table

The following sizing table is for Class 150 and 300 valves with PTFE seats at ambient temperatures and 10 bar pressure drop and is for reference only.

Valve Size	Double Acting (DA)			Spring Return (SR)		
	60 psi	80 psi	100 psi	60 psi	80 psi	100 psi
1/2"	C15	C15	C15	C20-2A2B	C15-1B2	C15-2
3/4"	C15	C15	C15	C25-2A2B	C20-2C	C20-3
1"	C20	C15	C15	C25-2A2B	C20-2C	C20-3
1 1/2"	C20	C20	C20	C30-2A2B	C25-2C	C25-3
2"	C25	C25	C20	C35-2A2B	C30-2C	C25-3
3"	C35	C30	C30	C45-2A2B	C35-2C	C35-3
4"	C45	C35	C30	C60-2A2B	C45-2C	C45-3
6"	C60	C45	C35	C75-2A2B	C60-2C	C60-3

Mounting Actuators or Gear Operators

When preparing a valve for actuation, make sure to follow the instructions below.

Stem arrangement for actuated valves

Valve sizes 1/2" to 2".

Release the wrench nut **1** and serrated washer **2**, remove the wrench **3** and refasten the wrench nut on the tab washer **4**. Remove the stop pin **5**. Valve sizes 1/2" and 2" do not require the wrench nut **1**.

Manual Valve stem assembly

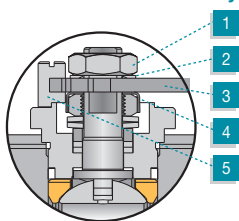

Actuated Valve stem assembly

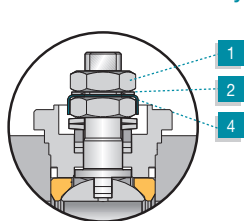

Valve sizes 3" to 6".

Release the wrench bolt **1** and remove the wrench handle **2** wrench head **3**, gland nut **4** and stop plate **5**. Assemble the two disc springs **6** stem location ring **7** tab washer **8** and refasten the non-slotted gland nut **9**.

Manual Valve stem assembly

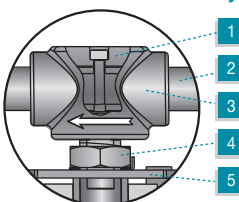

Actuated Valve stem assembly

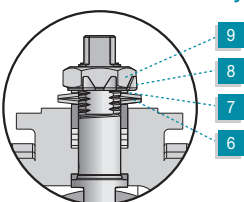

Valve Installation

Habonim flanged valves are delivered in the open position and with flange protection covers. Flanged valves are installed directly into the pipe line. When installing the valves in-line, follow the bolt tightening patterns shown below, using the recommended torque figures for safe operation. For more information, please refer to the Installation, Operation and Maintenance manual of the Habonim Flanged valves.

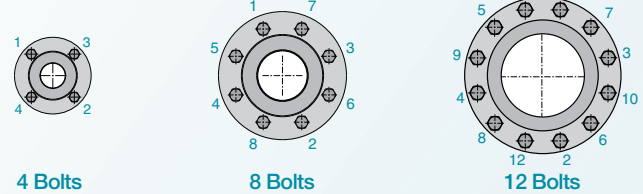

Valve Size (in)	Valve Size (DN)	ANSI 150		ANSI 300	
		Nm	in.lb	Nm	in.lb
1/2"	15	80	710	80	710
3/4"	20	80	710	140	1,240
1"	25	80	710	140	1,240
1 1/2"	40	80	710	240	2,120
2"	50	140	1,240	140	1,240
3"	80	170	1,500	250	2,210
4"	100	170	1,500	250	2,210
6"	150	170	1,500	250	2,210

Locking Device

LLP (Locked in Last Position)

The Habonim spring loaded locking device (LD) is ideal for applications where it is critical to keep the valve position without the risk of accidental operation.

The locking device fits easily to the valve stem by simply removing the stem nut and threading the lock stem above the handle. The LD can lock the valve in the closed or open position. The LD can be fitted to the valve in-line. Available in sizes 1/2" to 2".

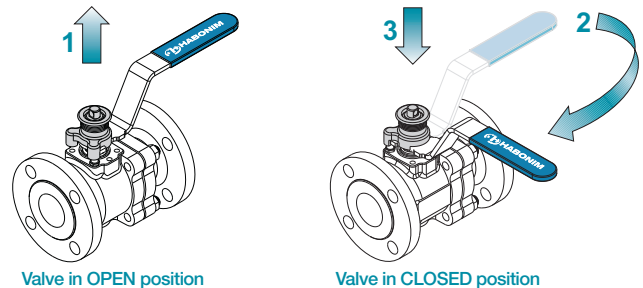

Antistatic Device

The antistatic device discharges static electricity buildup on the ball, conforming to BS 5351 for continuous electrical contact between ball/stem and stem/body. The contact is made by a spring loaded stainless steel element inserted in the stem or a conductive PTFE stem seal. Valve sizes up to 2" feature a stem/body contact, while larger size valves have also a ball/stem contact.

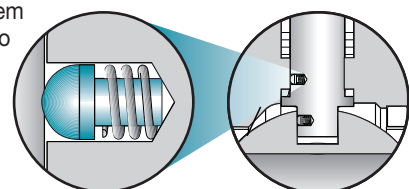

FLANGED FULL BORE BALL VALVES

73P&74P SERIES

How to order The HABONIM 73P&74P Identification Code

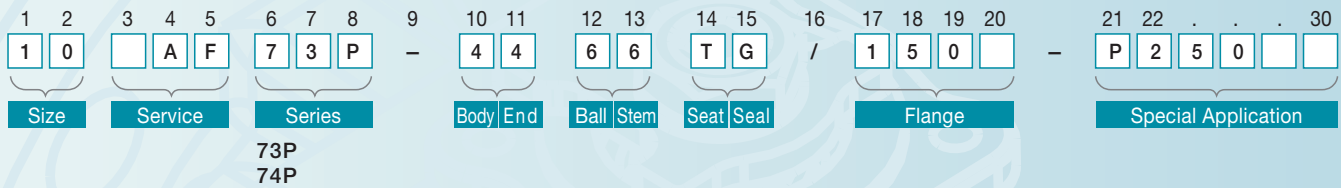

Size			Service		Body / End Ball / Stem		Seat		Seal		Special Application		
Code	inch	mm											
05	1/2"	15	A	Antistatic	4	Carbon Steel	A	TFM	G	Expended Graphite	A0866	Stem seal Ammonia service	
07	3/4"	20	C	Cryogenic	6	S. St. 316 (L)	C	PCTFE	I	Impregnated Graphite	P043	Stem seal for gas service	
10	1"	25	D	Diverter	7	Monel	F	PFA	M	S. St O-Ring	F043	Stem seal Neoprene	
15	1 1/2"	40		Bottom entry	8	S. St. 304	H	VX1	R	Reinforced	P250	Ball with Pressure relief hole	
20	2"	50	F	Firesafe	9	C. Steel LCB	J	Reinforced		15% Glass filled PTFE	VB30	Characterized control ball	
30	3"	80	N	Dry Chlorine	A	Alloy-20	K	25% Glass filled PTFE	T	PTFE	DBB	Double Block & Bleed	
40	4"	100	K	Control	C	Hastelloy-C	L	Virgin PEEK®	U	Uhmwpe	NACE	Nace service	
60	6"	150	O	Oxygen	D	Duplex	M	Metal	V	Viton®	WR	DD Stem	
			Q	Cavity filler	M	S. St. 17-4PH	P	NRG	Flange			FF	Flat Face
			S	Diverter	Z	Inconel 718	R	Reinforced	150	ANSI 150 RF	HC	High Cycle stem arrangement	
				Side entry	W	Hastelloy-C22		15% Glass filled PTFE	300	ANSI 300 RF	SRS	Self Relieving Seat	
			V	Vacuum	K	Super Duplex	S	VESPEL®	PN16	ANSI RF	DHN	DHN coating	
			W	Steam & Thermal fluid	S	254SMO	T	PTFE	PN40	Drilled to DIN			
			X	Metal seats			U	UHMWPE					
							Y	Derlin®					

In some applications the available options above are limited to specific sizes. Please consult with Habonim for details.

Standards of Compliance	
Flanges:	ANSI B16.5 Raised Face BS 1560 class 150, 300
Face-to-Face:	ANSI B16.10 Short Pattern
Antistatic:	BS 5351 ISO 17292
Design:	LR Type App. BS 5351&API 6D ANSI B16.34, BS 5159
Pressure Testing:	API 598 ISO 5208, BS EN 12266 Pt. 1&2
Fire Testing:	API 607 5th Edt. API 6FA BS 6755 Pt. 2 ISO 10497
NACE (option must be specified)	MR0175
Quality Assurance:	ISO 9001-2008
Certification:	PED 97/23/EC ISO -10474 DIN EN 10204 3.1.B ATEX Directive 94/9/EC

How to order

When placing an order for HABONIM valves, please provide as many details possible on the application such as:
Media, Temperature, Pressure, Pipe line size and type of connection.

Example: 20 AF73P - 446MTG / 150

Size 2" (20), Antistatic (A), Firesafe (F), Full Bore ANSI 150 (73P), C. St Body & End Cap (44), S. St 316 Ball, 17- 4PH Stem (M), PTFE Seats (T), Graphite Body Seal (G), ANSI 150 RF Flange (150).

Quality Assurance

As an ISO 9001- 2000 certified company, Habonim operates according to internal manufacturing specifications that are written for each application and for specific customers. From the design stages to final inspection of assembled valves, Habonim controls its procedures for the integrity of the parts, their manufacturing process, storing and preservation and final assembly, to keep the highest standards of perfection of the product. All valves are 100% leak tested before packaging. Each valve is tagged for traceability and material certification can be provided on request.

DELTRIN® is a registered trademark of DuPont, VESPEL® is a registered trademark of DuPont, KEL-F® is a registered trademark of 3M Company
NYLATRON® is a registered trademark of Quadrant DSM Engineering Plastic Products, TFM™ is a trademark of Dyneon, PEEK® is a trademark of VICTREX
In accordance with our policy to strive for continuous improvement of the product, we reserve the right to alter the dimensions, technical data and information included in this catalogue when required.

Copyright © 2009 HABONIM Ltd. All rights reserved



HABONIM USA

Toll Free Phone: 1-866-261-8400
Toll Free Fax: 1-866-243-9959
sales_usa@habonim.com

HEADQUARTERS HABONIM ISRAEL

Tel: +972-4-6914911
Fax: +972-4-6914902
sales_international@habonim.com

www.habonim.com

CAT73PP-2131 10/09

